

→ cut guide
—●— fold guide

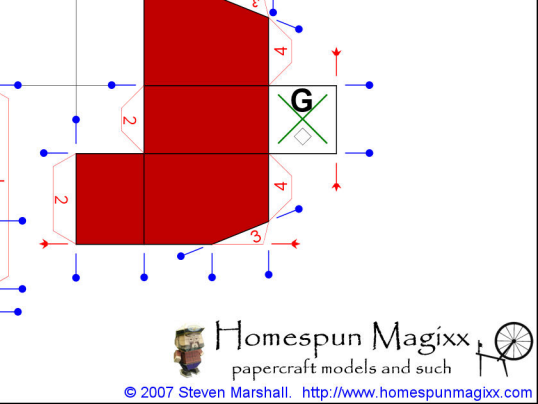

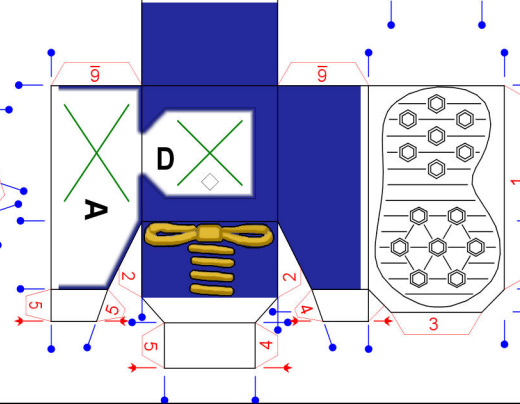
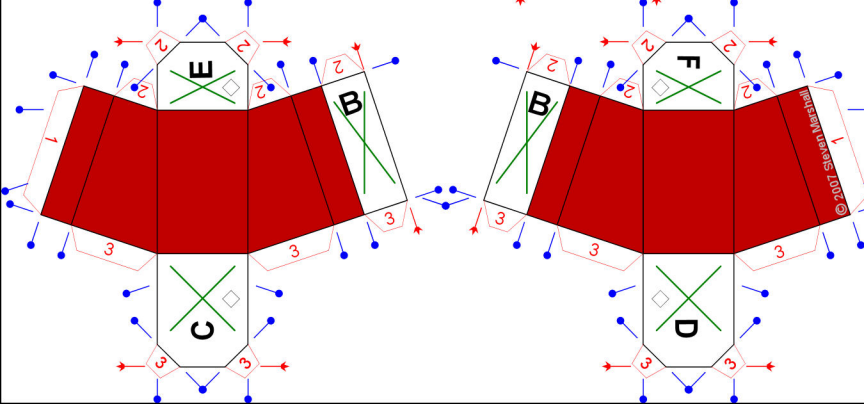
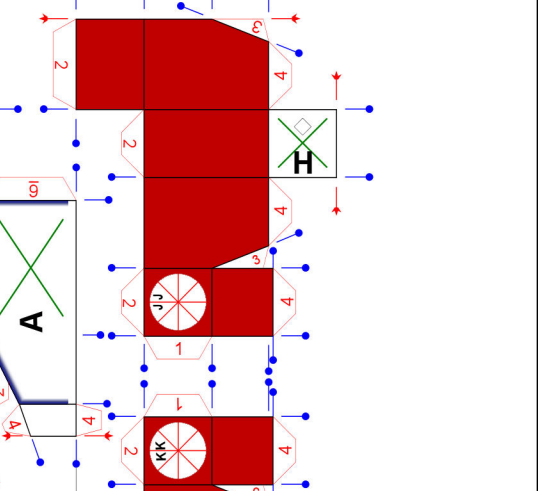
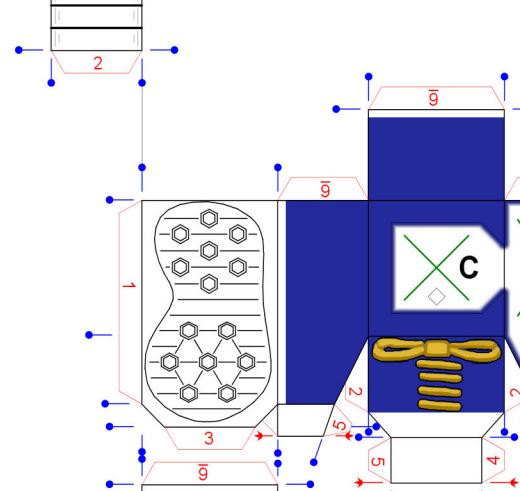
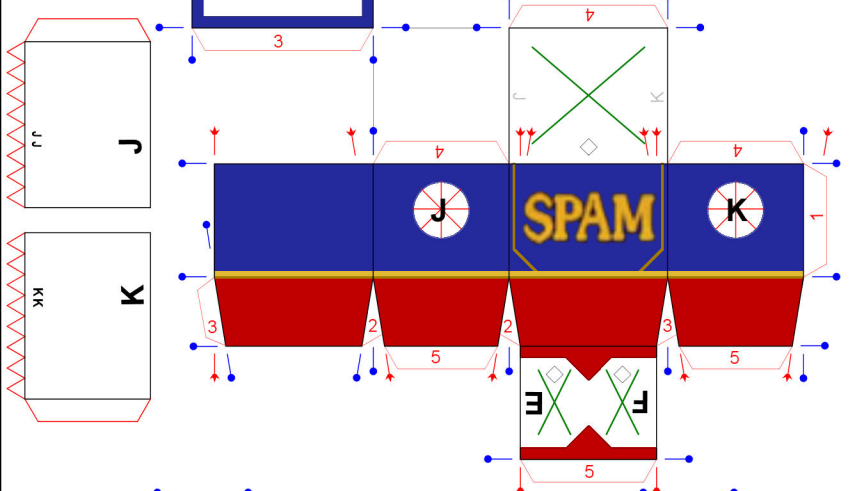
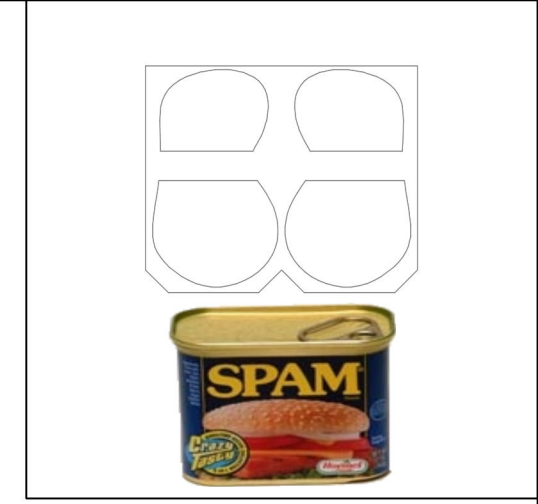
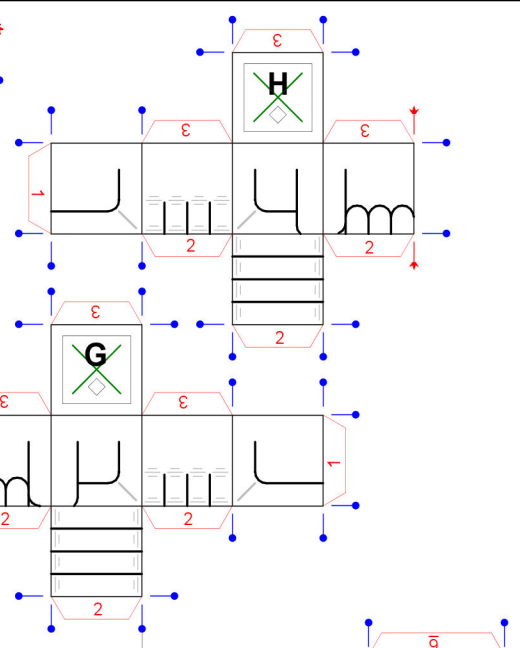
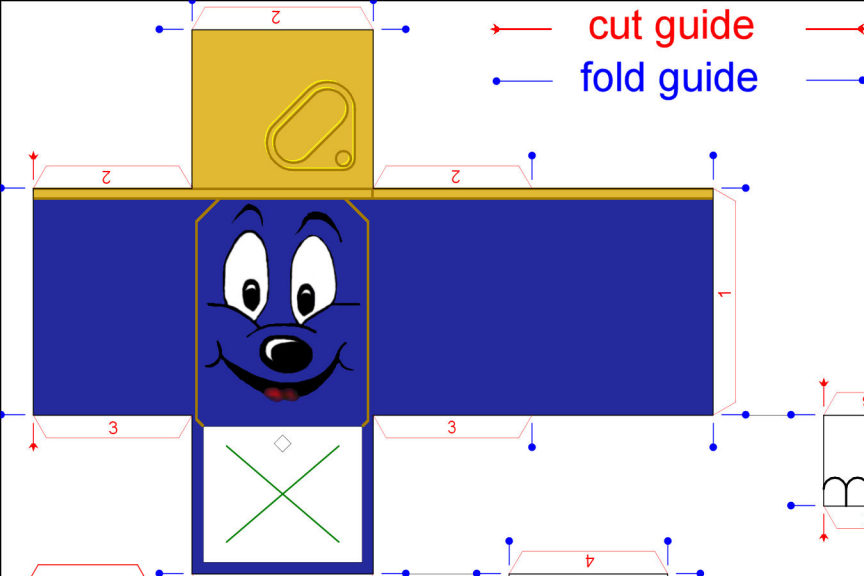
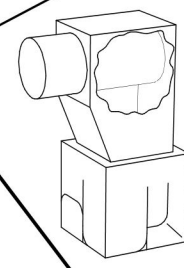
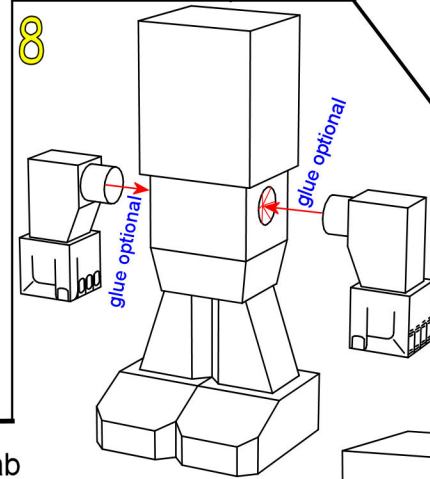
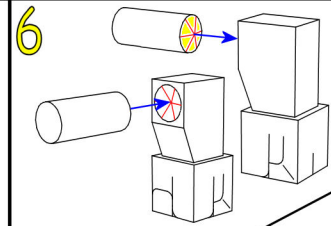
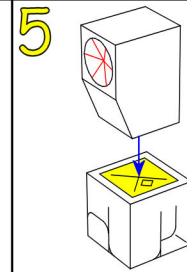
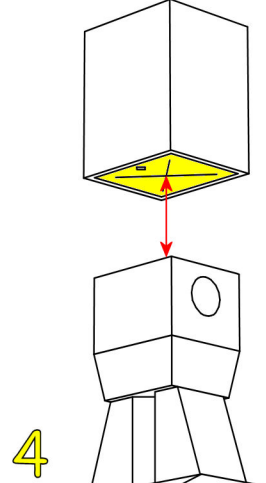
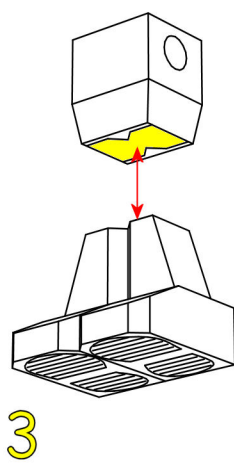
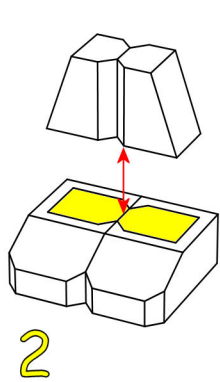
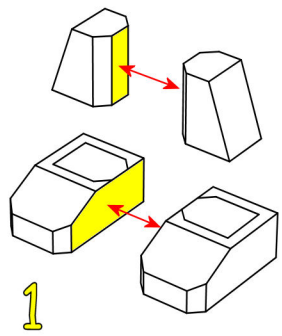

Assembly Instructions

- Before cutting, carefully score all fold lines using the ruler and awl or other pointed tool. Be careful not to cut through the paper.
- Use the ruler and craft knife to carefully cut out each piece.
- Fold and dry fit each piece before gluing.
- Assemble by gluing tabs in sequence indicated by numbers on tabs.
- Use a toothpick or small paintbrush to apply glue to the glue tabs.
- Use tweezers or pliers to clamp the glue tabs until dry.

Tools and materials

Ruler - scissors - craft knife - awl or other pointed tool for scoring fold lines - white glue - cutting mat - toothpicks or small paintbrush - tweezers or needle-nose pliers.

Caution

Knives and scissors should only be used with proper adult supervision. Use glue sparingly and only in a well ventilated area.

Printing tips

Print on 67 lb Cover Stock or 110 lb Card Stock
Select "Auto-rotate and Center", Do not select "Fit to Page"

LEGEND

